

THE PATH

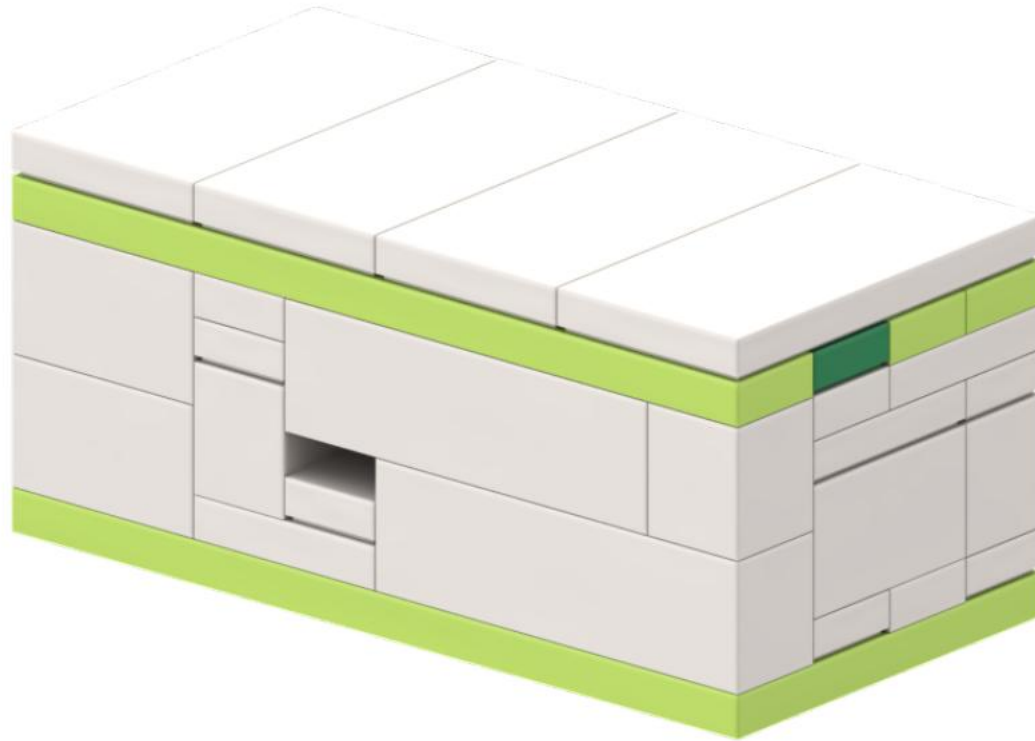

Hi !

Thank you for downloading the DIY manual of one of our puzzles.
If you liked it, go check our other creations on our website:

www.puzzle-bricks.fr

We sell convenient packs with all the pieces needed (including the Zombricks) to build each of our puzzles.

If you downloaded this manual freely, consider donating to us at the following adress:

paypal.me/puzzlebricks

Follow our socials:

 [instagram.com/puzzlebricks](https://www.instagram.com/puzzlebricks)

 twitter.com/PuzzleBricks

The PuzzleBricks Team



You have in your hands one of our puzzles. The last page of this manual contains the list of all the bricks you will need !

Don't worry buddy 🤠 the following pages will guide you through the steps to build your puzzle.

ZOMBRICKS :



To create your special pieces be sure to follow the Zombricks Manual ! They will be crucial during the assembly of your puzzle. If you bought one of our puzzle, Zombricks are separated from the other pieces.

GOAL :

The goal is to reveal the green bill as on the picture below :



RULES:

- Take of the stick on top of the puzzle, it will serve you as a tool
- If it blocks, it means that you're not in the right direction. Do not force on your puzzle buddy !
- All the moves are allowed: push, pull, turn over the puzzle, shake... except to throw it on the ground or take it apart of course ! :)

1

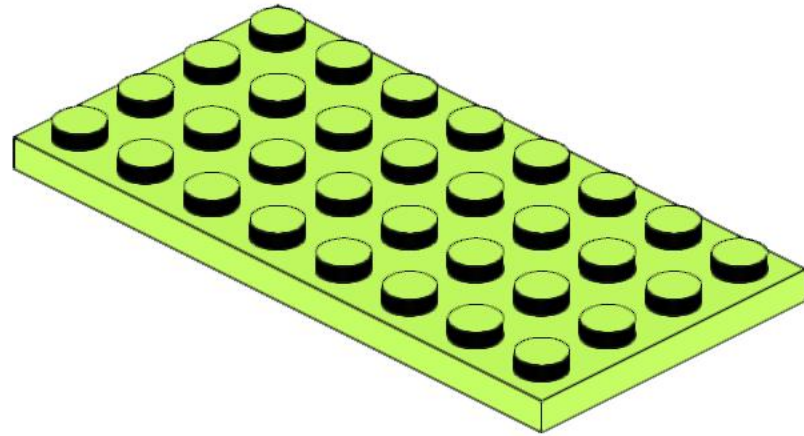
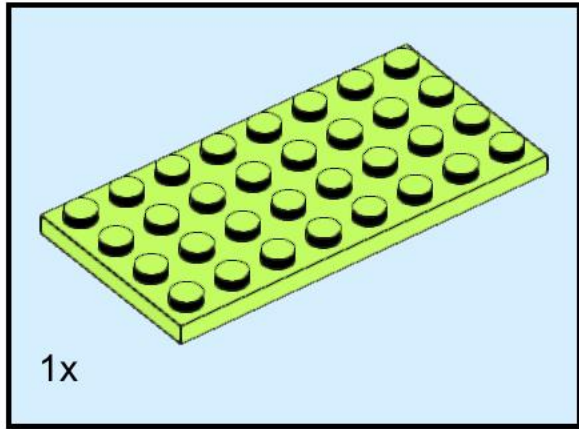

2

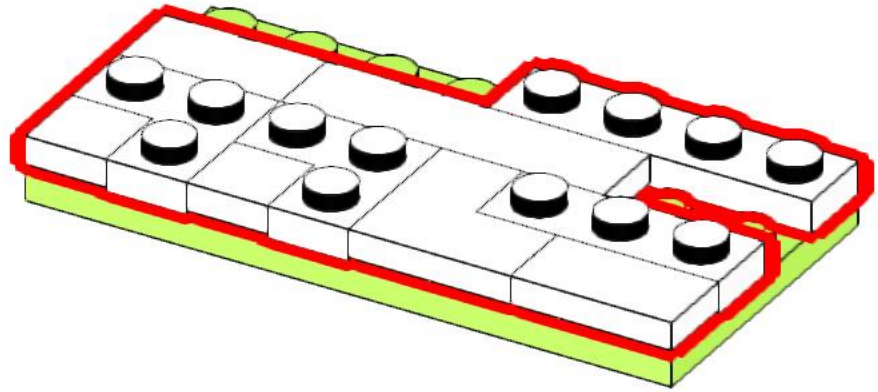
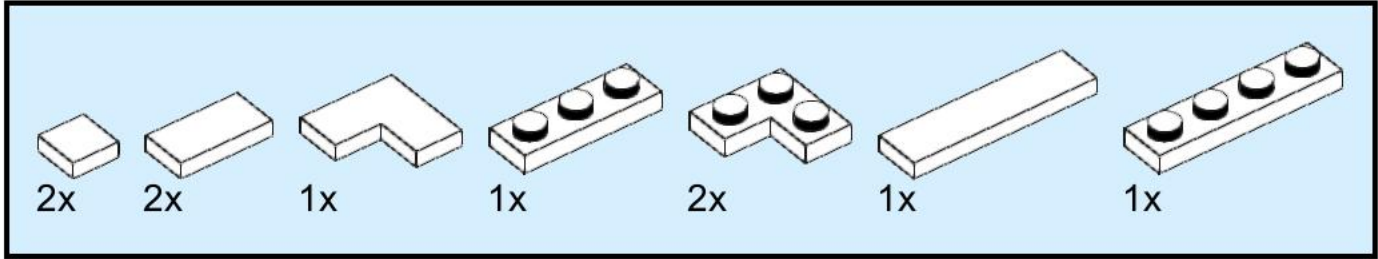

3

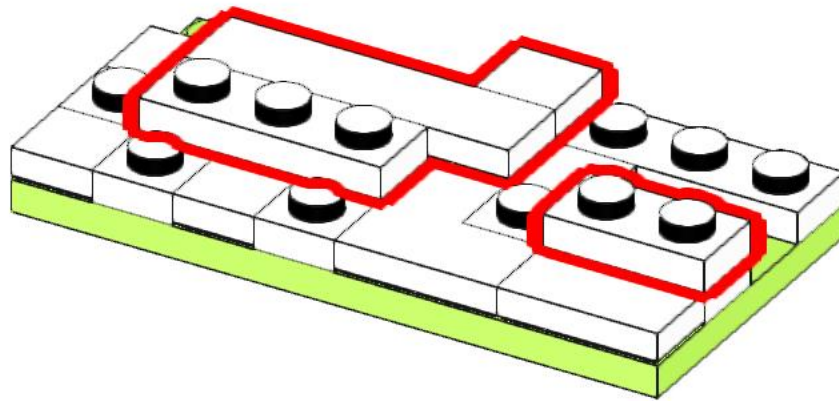
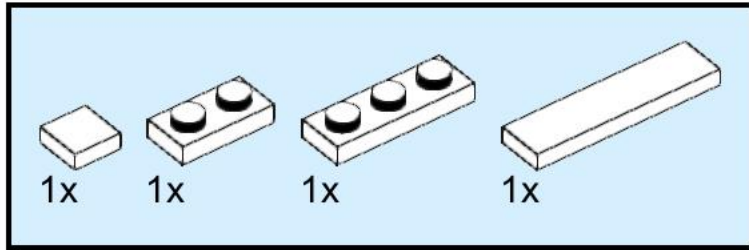

4

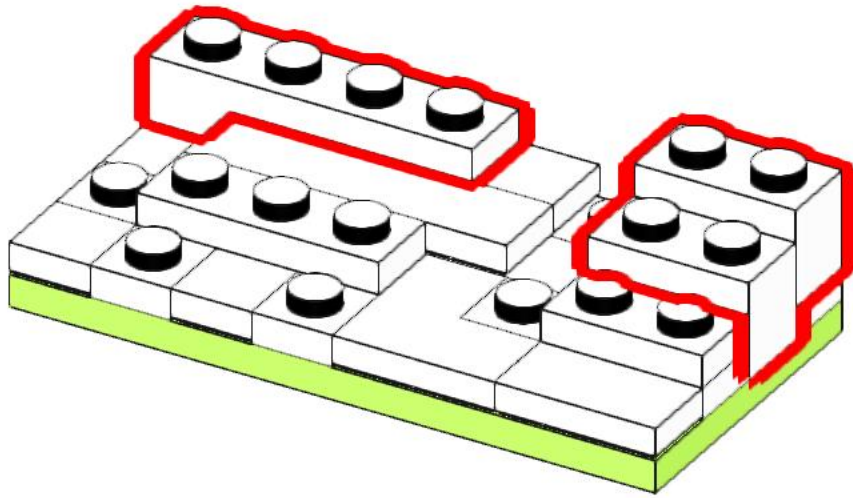
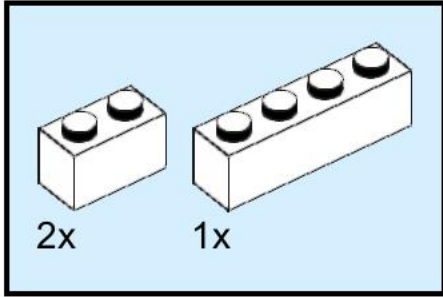

5

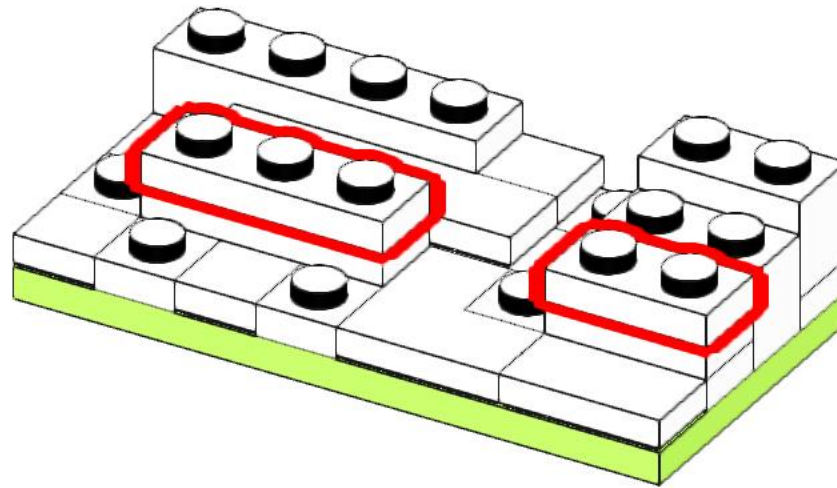
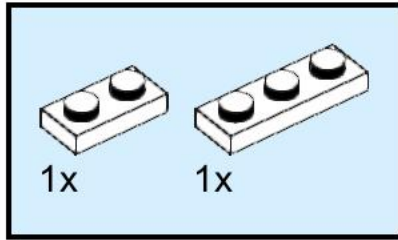

6

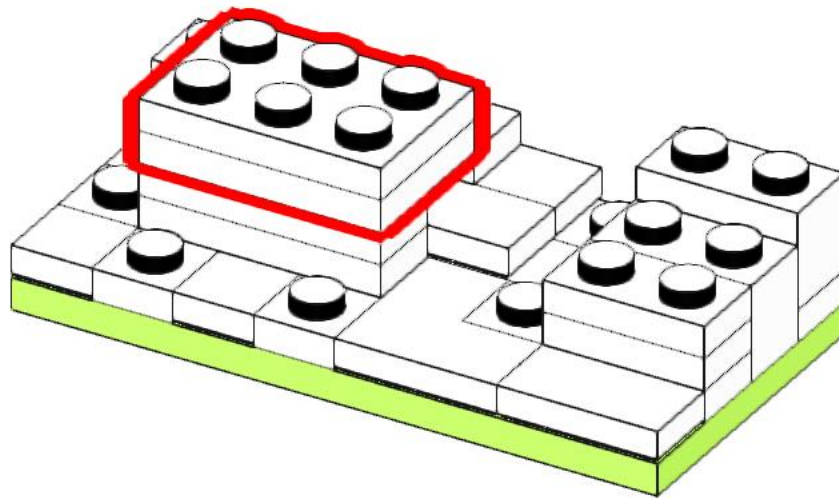
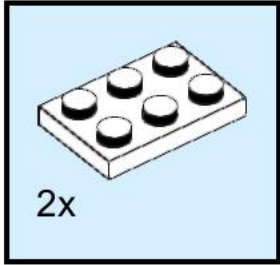

7

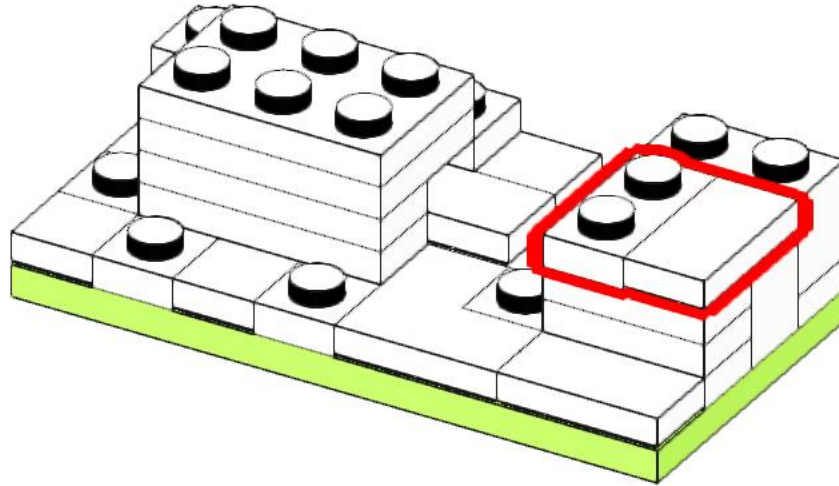
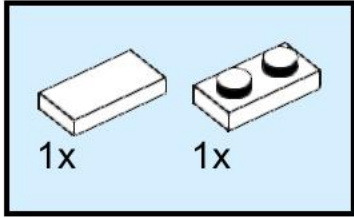

8

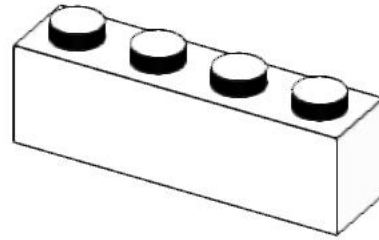
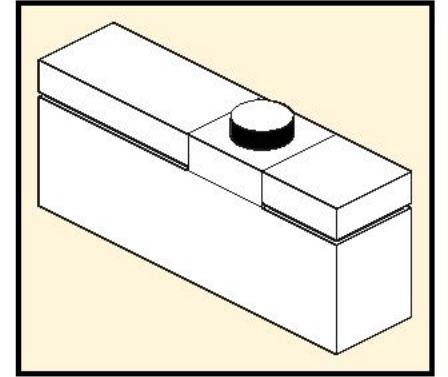
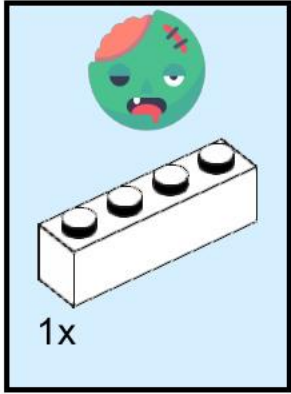

9

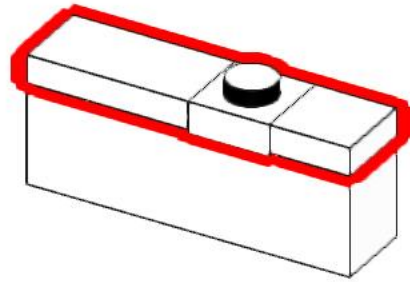
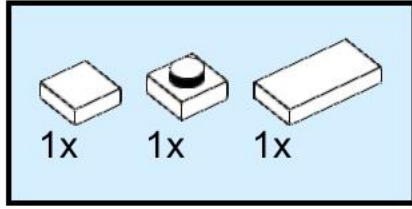

10

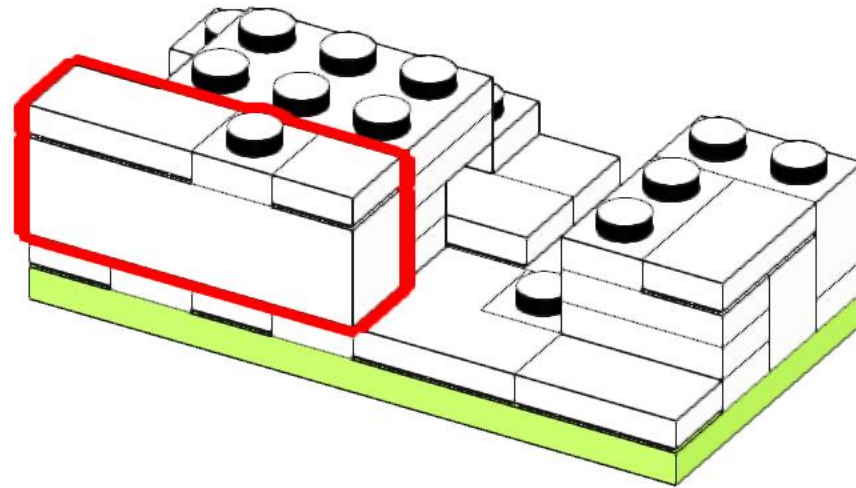

11

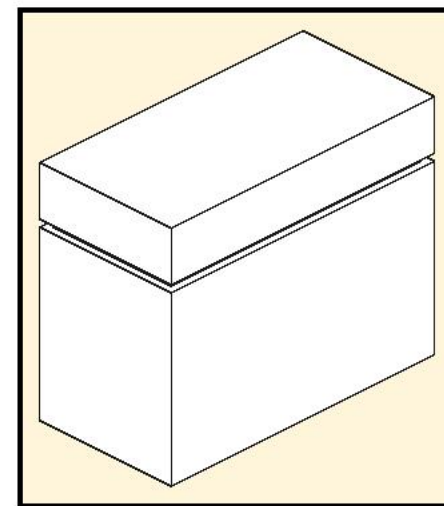
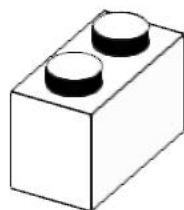
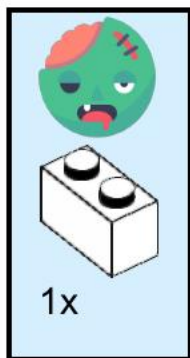

12

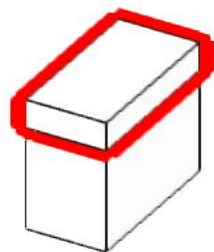
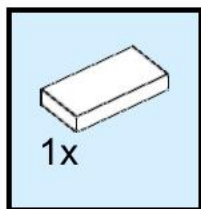

13

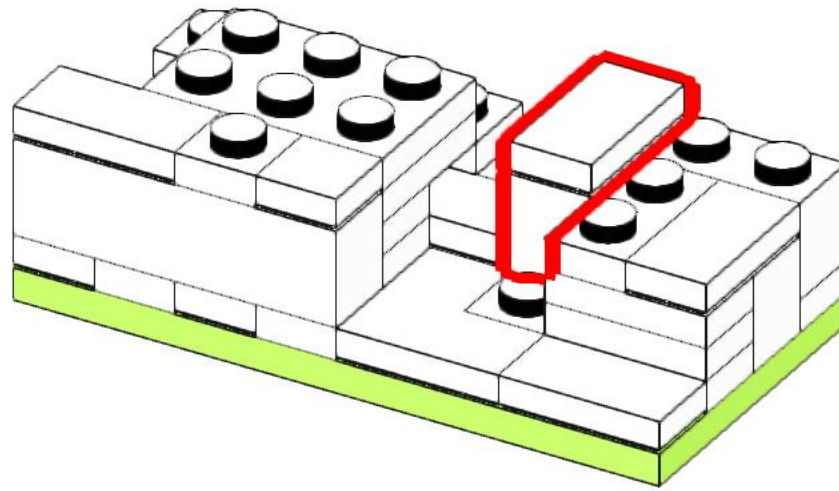

14

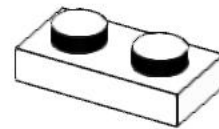
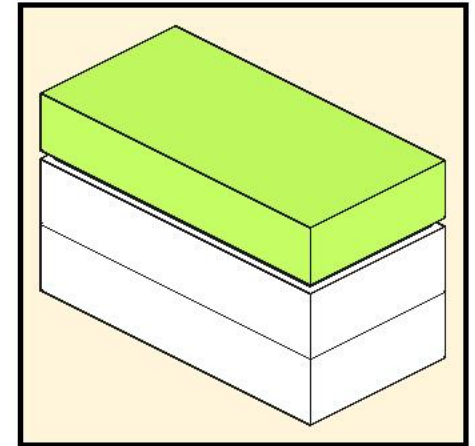
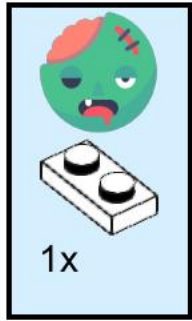

15

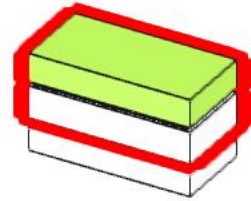
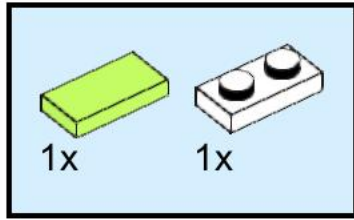

16

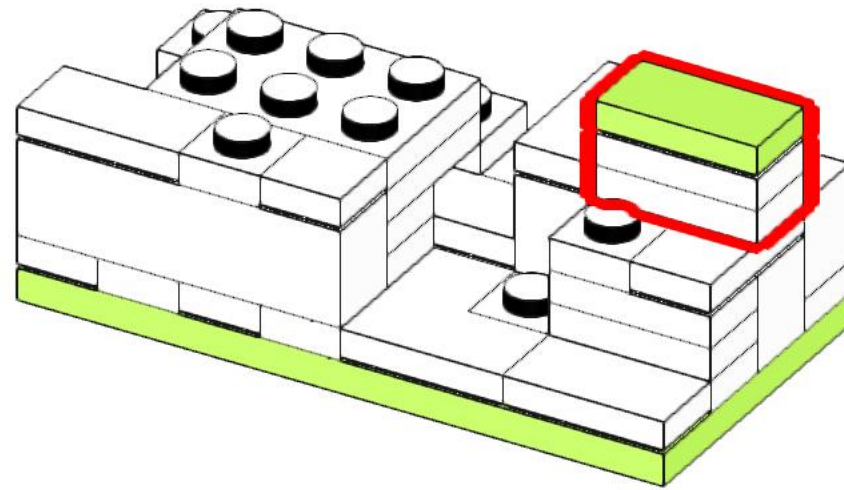

17

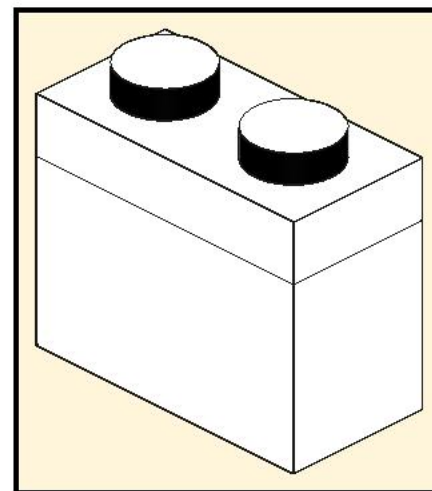
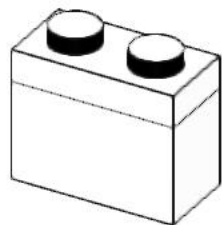
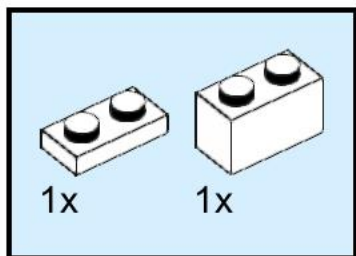

18

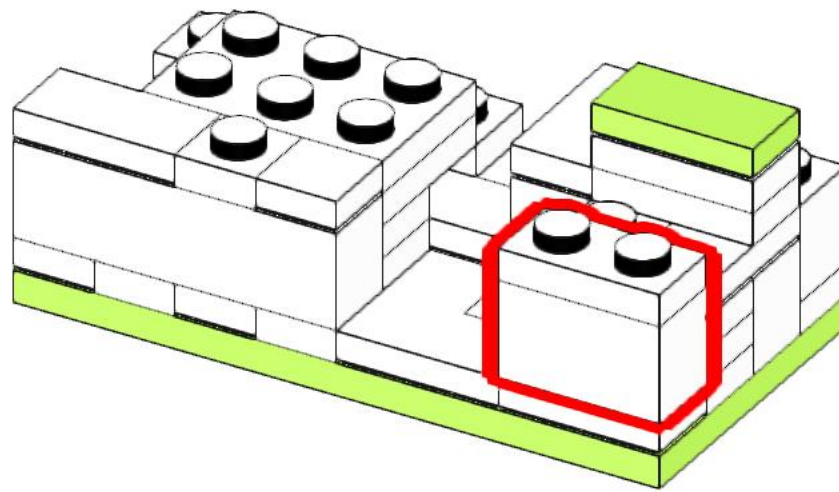

19

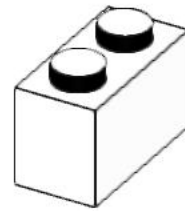
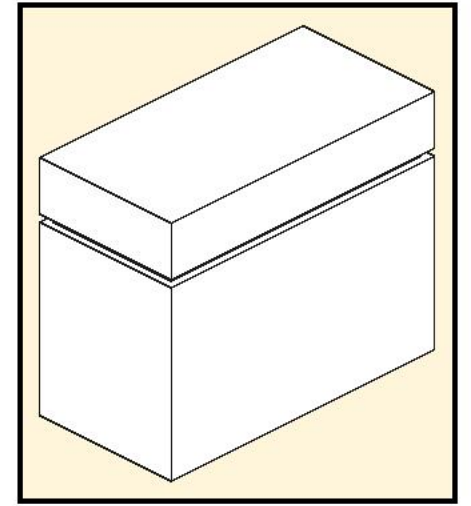
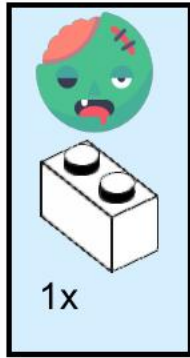

20

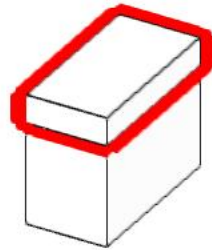
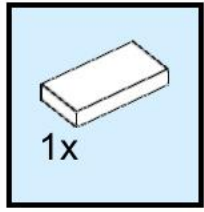

21

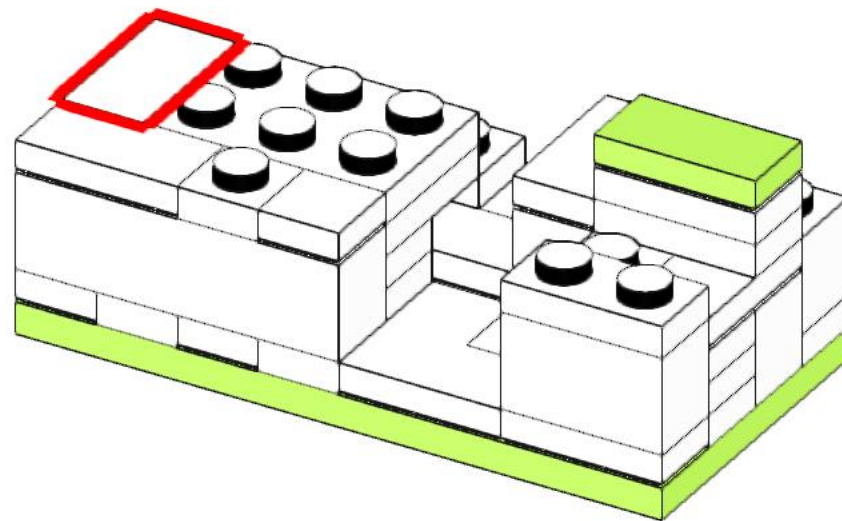

22

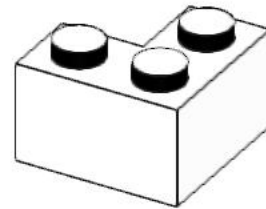
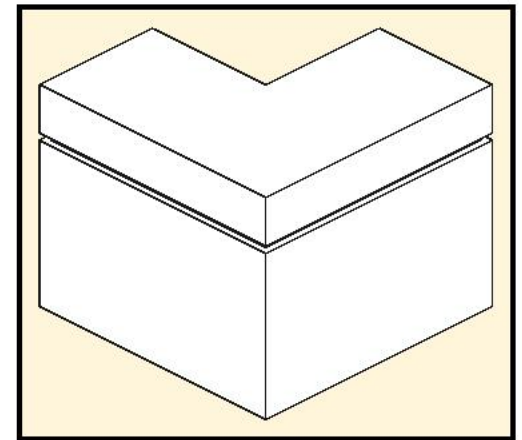
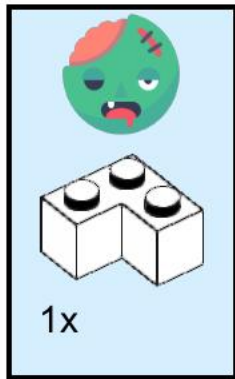

23

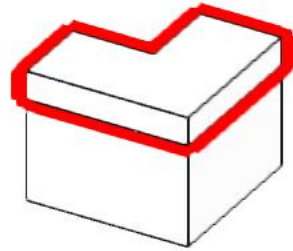
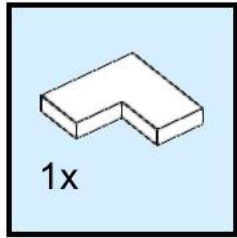

24

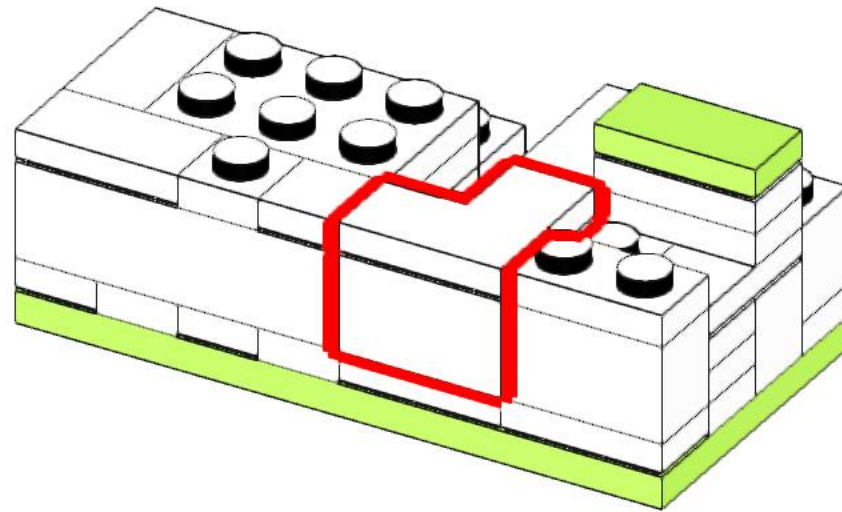

25

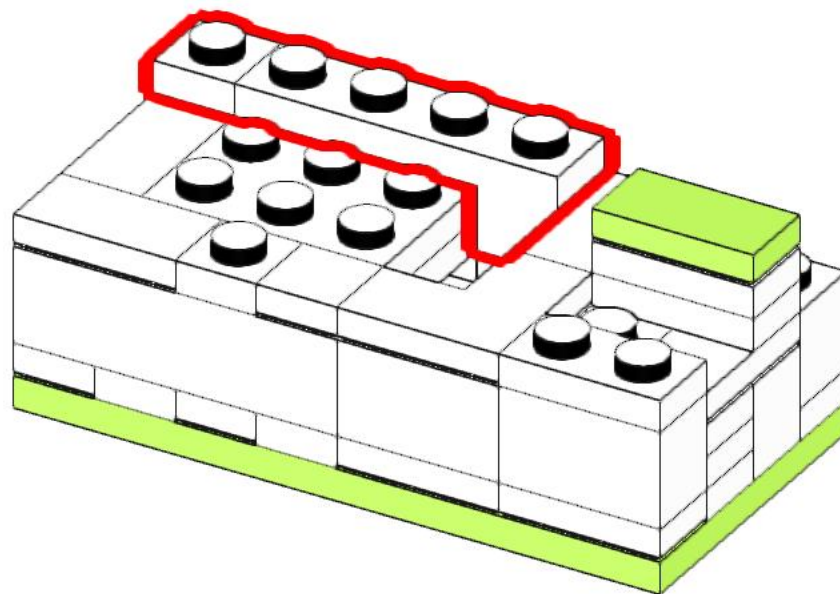
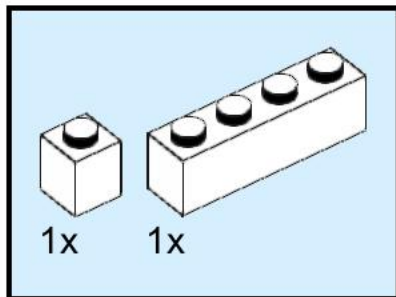

26

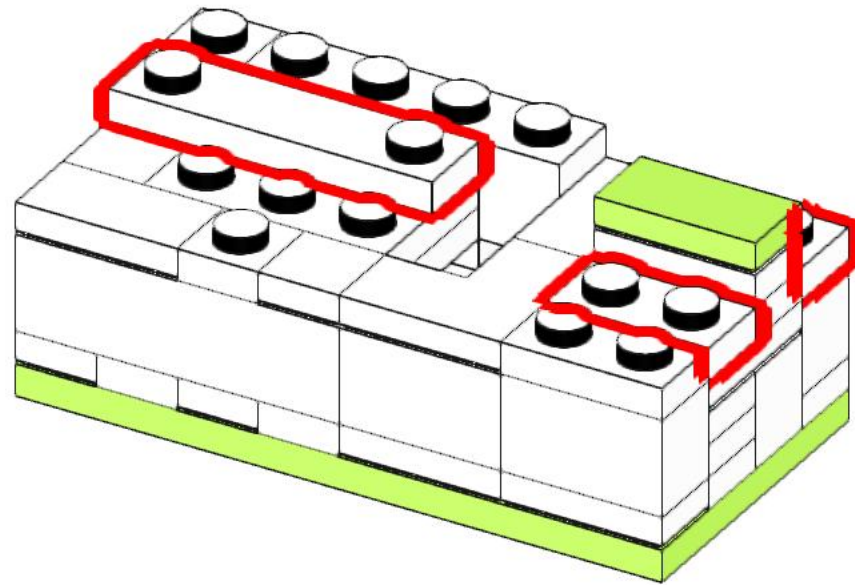
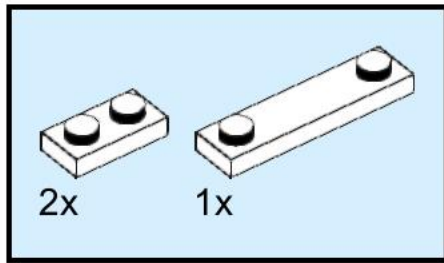

27

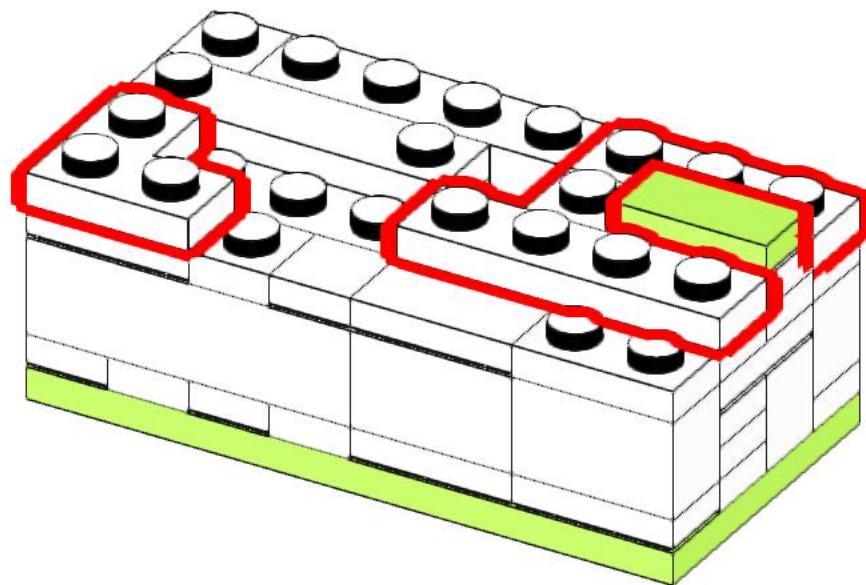
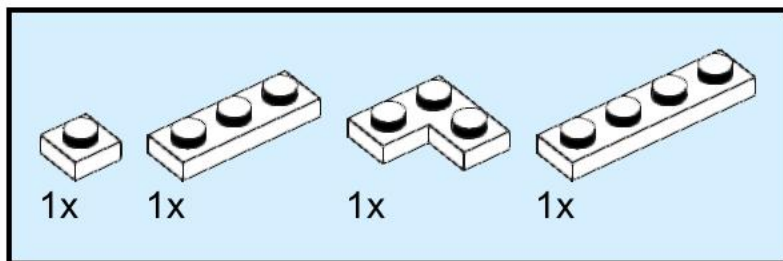

28

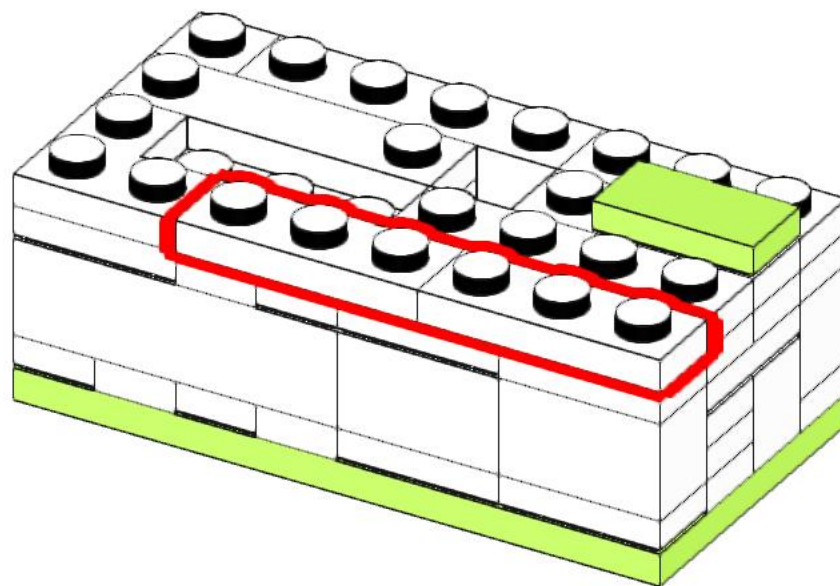
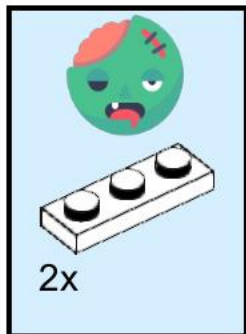

29

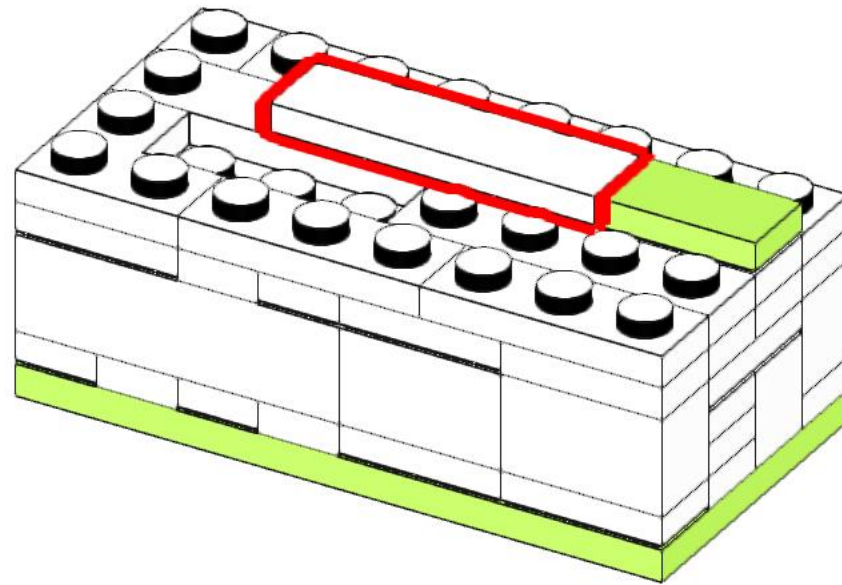
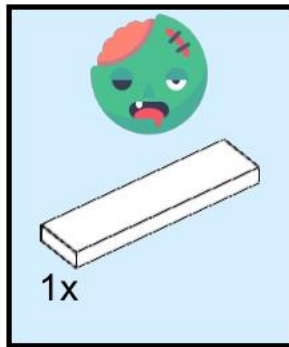

30

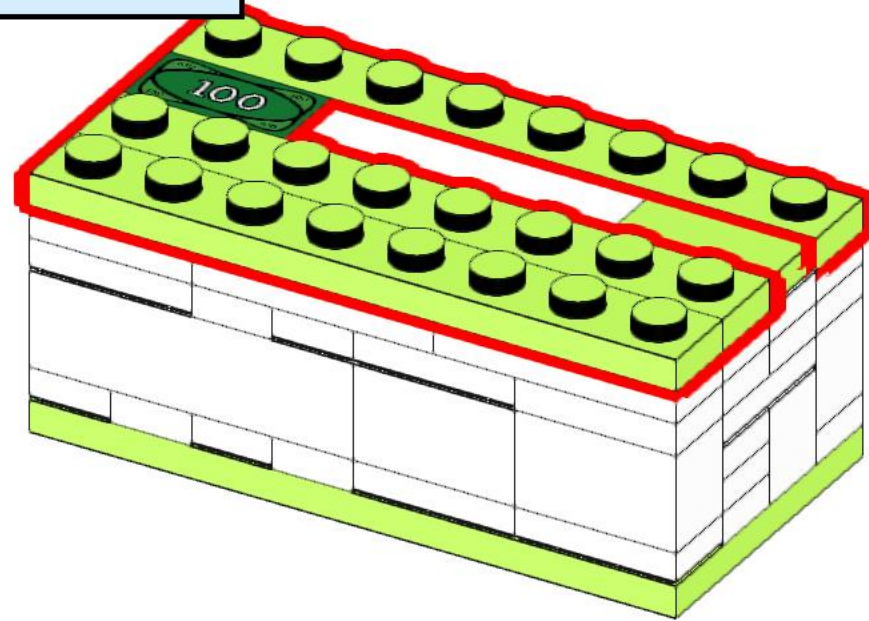
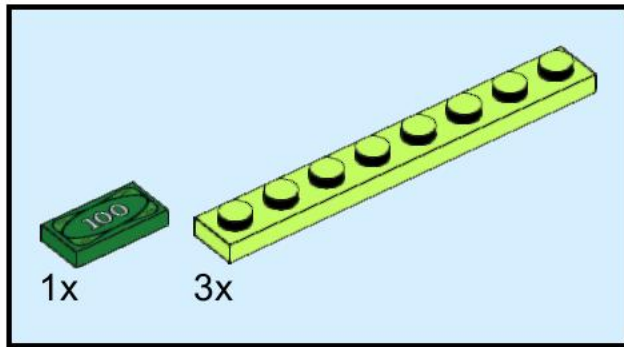

31

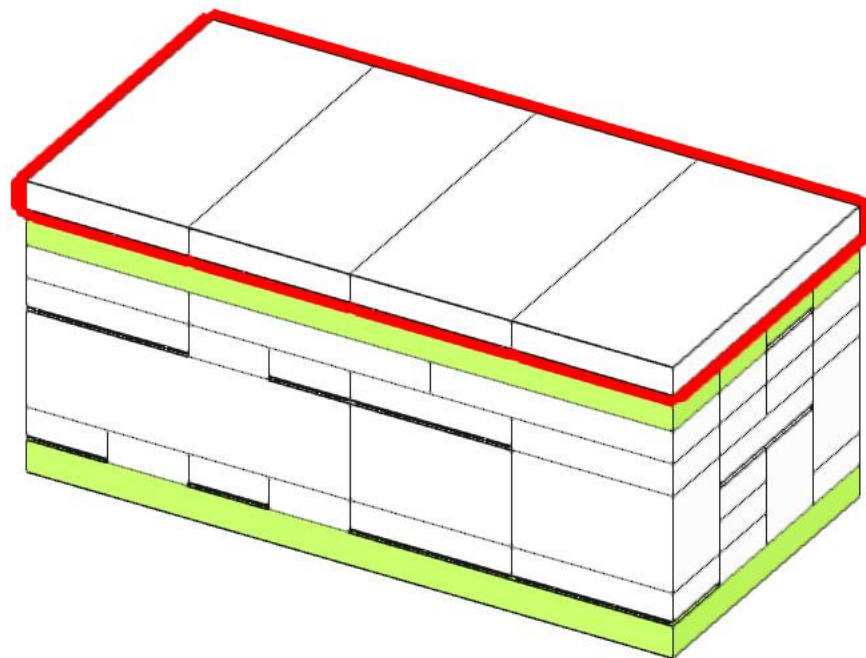
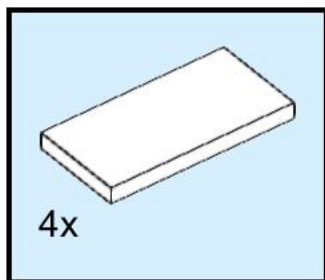



4x
3070b, 1

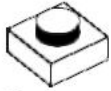

2x
3024, 1

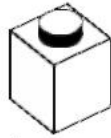

1x
3005, 1

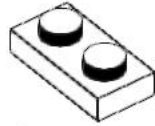

1x



6x
3069b, 1

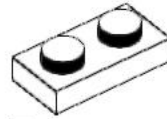

7x
3023, 1

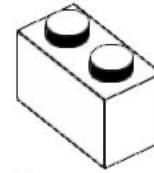

2x

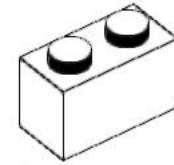

3x
3004, 1

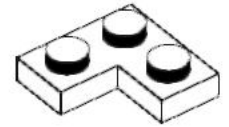

3x
2420, 1

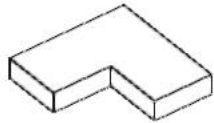

2x
14719, 1

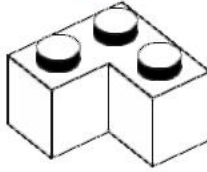

1x
2357, 1

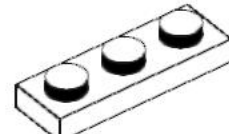

2x

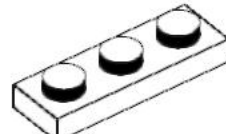

4x
3623, 1

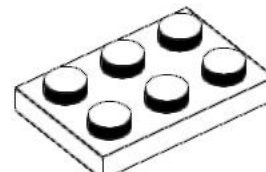

2x
3021, 1

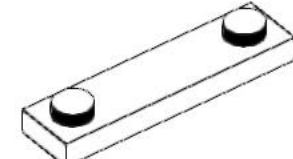

1x
92593, 1

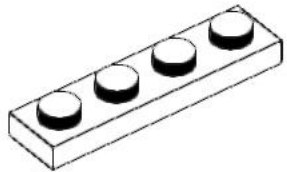

2x
3710, 1



1x



2x
2431, 1

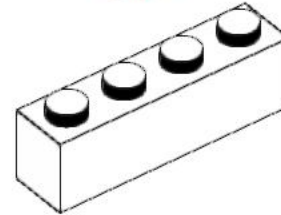

1x

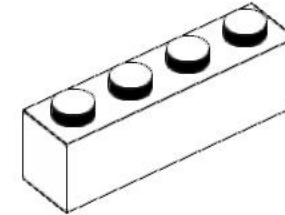

2x
3010, 1

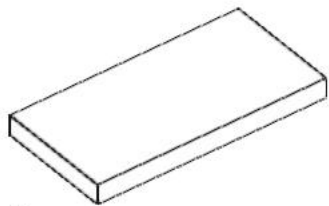

4x
87079, 1

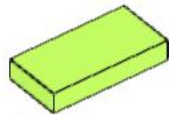

1x
3069b, 166

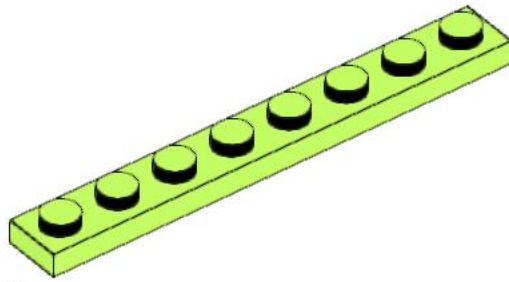

3x
3460, 166

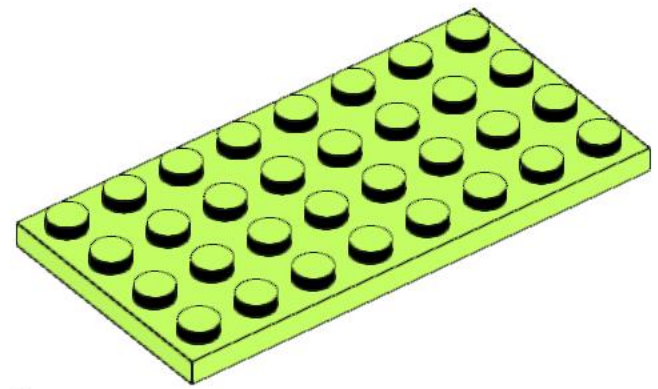

1x
3035, 166



1x
3069bpx7, 6